

NOTES:

1. GLASS THICKNESS 1.8mm NOMINAL
2. FINISHED PART THICKNESS 2.16mm NOMINAL
3. FINISHED PART THICKNESS AT CABLE ATTACHMENT AREA 2.32mm MAX
- ④ LABEL TO BE ATTACHED TO FRONT SIDE OF CABLE
5. CABLE IS ATTACHED TO THE LEFT SIDE OF TOUCHSCREEN AT CENTER POINT AS SHOWN
- ⑥ FINISHED PART THICKNESS AT THE COVERSHEET CONTACT 2.28mm MAX

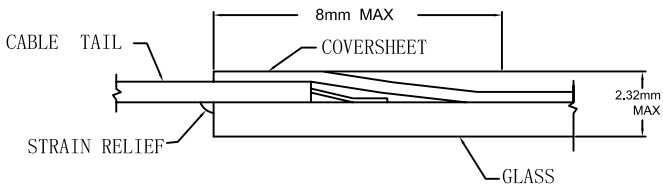
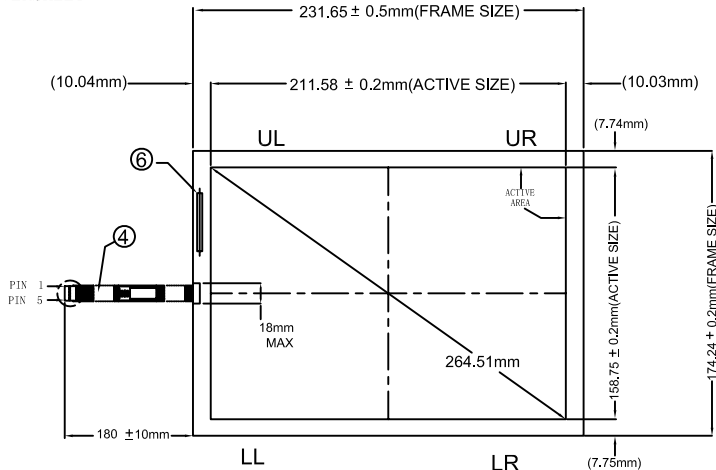

**CONNECTOR
PINOUT**

PIN NO.	DESIGNATION
1	UR
2	LR
3	Sense
4	UL
5	LL

vtouch
VTOUCH P/N: T3R-10.4-20
DESCRIPTION 10.4" 5-Wire Resistive TouchScreen
UNIT mm
DATE 08/08/22
SHEET 1 OF 1